

Nr Art. 00.101.01.0-A02 | Korpusy | Standard

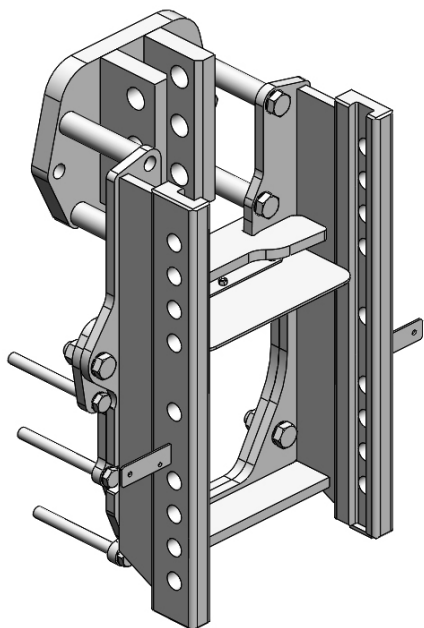

Wymiary Scharmüller S32 (330/25/32)

Alternatywa Kolory

00.101.01.0-A02 (czarny)





Techniczne wartości*

Maks.dopuszczalna wartość D (kN): 82,4 | Maks.dopuszczalny nacisk pionowy (kg): 2500

Odpowiednie ciągniki

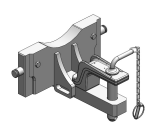
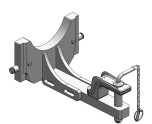
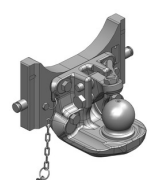
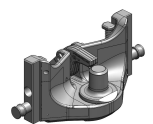
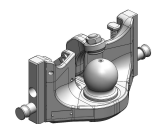
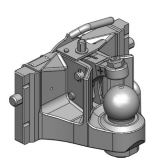
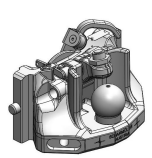
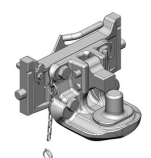
Case IH: **Magnum 7100/7200:** 7110, 7120, 7130, 7140, 7150, 7210, 7220, 7230, 7240, 7250; **Magnum 8900:** 8910, 8920, 8930, 8940, 8950;
 Steyr: **9200:** 9220, 9250, 9270;

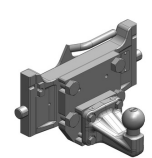
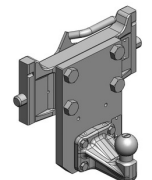
Kompatybilny z

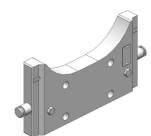
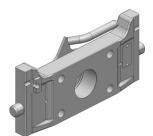
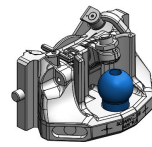
<p>Nr Art. 00.833.00.0-A02 Wkłady</p> 	<p>Nr Art. 00.833.01.0-A02 Wkłady</p> 	<p>Nr Art. 03.6330.44-A02 Wkłady</p> 	<p>Nr Art. 05.6330.16-A02 Wkłady</p> 	<p>Nr Art. 05.6330.51-A02 Wkłady</p> 
<p>Nr Art. 05.6330.61-A02 Wkłady</p> 	<p>Nr Art. 05.6330.70-A02 Wkłady</p> 	<p>Nr Art. 07.6330.32-A02 Wkłady</p> 	<p>Nr Art. 07.6330.42-A02 Wkłady</p> 	<p>Nr Art. 07.7330.04-A02 Wkłady</p> 
<p>Nr Art. 07.7330.05-A02 Wkłady</p> 	<p>Nr Art. 03.7330.60-A02 Płyty adaptacyjne z uchwytem</p> 	<p>Nr Art. 03.7330.65-A02 Płyty adaptacyjne z uchwytem</p> 	<p>Nr Art. 07.7330.52-A02 Płyty adaptacyjne z uchwytem</p> 	<p>Nr Art. 85.6330.70-A02 Lenkkugel K80® EAMS</p> 

Kompatybilny z

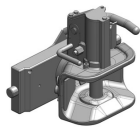
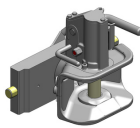
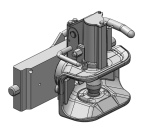
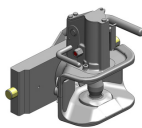
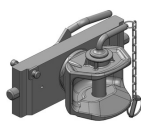
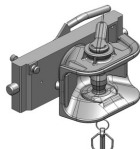
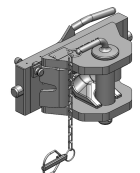
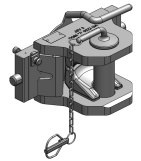
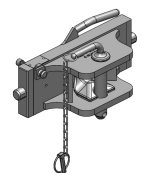
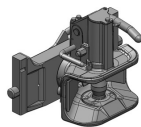
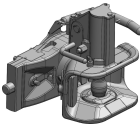
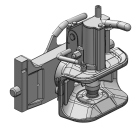
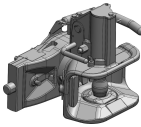
<p>Nr Art. 03.3301.121-A02 Standard z płytą adaptacyjną</p> 	<p>Nr Art. 03.3301.221-A02 Standard z płytą adaptacyjną</p> 	<p>Nr Art. 03.3303.121-A02 Standard z płytą adaptacyjną</p> 	<p>Nr Art. 03.3303.221-A02 Standard z płytą adaptacyjną</p> 	<p>Nr Art. 03.3305.011-A02 Standard z płytą adaptacyjną</p> 
<p>Nr Art. 03.3305.06-A02 Standard z płytą adaptacyjną</p> 	<p>Nr Art. 03.3306.031-A02 Standard z płytą adaptacyjną</p> 	<p>Nr Art. 03.3307.031-A02 Standard z płytą adaptacyjną</p> 	<p>Nr Art. 03.3308.031-A02 Standard z płytą adaptacyjną</p> 	<p>Nr Art. 07.3303.121-A02 Standard z płytą adaptacyjną</p> 
<p>Nr Art. 07.3303.191-A02 Standard z płytą adaptacyjną</p> 	<p>Nr Art. 07.3303.221-A02 Standard z płytą adaptacyjną</p> 	<p>Nr Art. 07.3303.291-A02 Standard z płytą adaptacyjną</p> 	<p>Nr Art. 07.3301.50-A02 Zautomatyzowane</p> 