

Nr Art. 00.110.15.2-A02 | Korpusy | Krótki

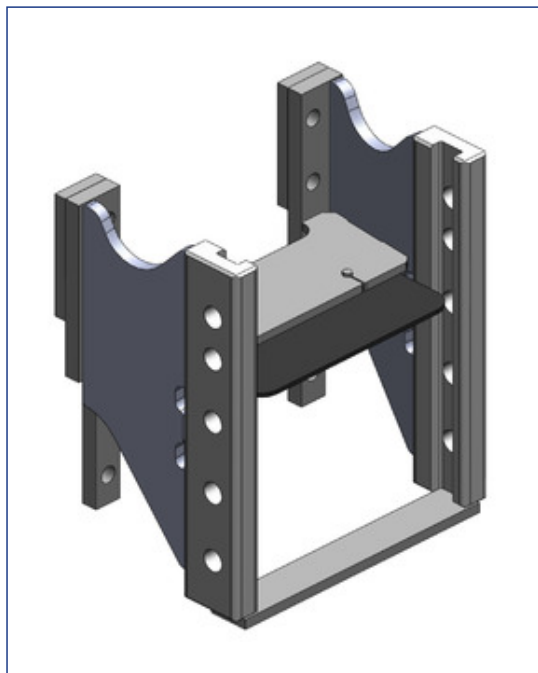

Wymiary Scharmüller S32 (330/25/32)	
Alternatywa Kolory	
00.110.15.2-A02 (czarny)	
Techniczne wartości*	
Maks.dopuszczalna wartość D (kN): 89,3 Maks.dopuszczalny nacisk pionowy (kg): 2500	
Odpowiednie ciągniki	
Case IH:	CS: 110, 120, 130, 150; CVX: 1135, 1140, 1145, 1150, 1155, 1170, 1175, 1190, 1195, 120, 130, 140, 150, 160, 170, 175, 190, 195;
Deutz-Fahr:	Agrotron 4.70-6.45 (MK1): 6.05, 6.15, 6.20, 6.30, 6.45; Agrotron 80-165 (MK2/MK3): 106, 110, 115, 120, 130, 135, 140, 150, 155, 165; Agrotron 80-180.7: 106, 108, 110, 115, 118, 120, 128, 130, 135, 150, 150.7, 165.7, 180.7; Agrotron M: 410, 420, 600, 610, 615, 620, 625, 640, 650; Agrotron TTV: 630;
Doppstadt:	Trac: 100, 130, 150, 160, 180, 200;
Hürlimann:	XL: 130, 140, 150, 150.7, 160, 165.7, 175, 180.7, 185;
Lamborghini:	R6: 130, 140, 150, 150.7, 160, 165.7, 175, 180.7, 185;
New Holland:	T7500: 7510, 7520, 7530, 7540, 7550; TVT: 135, 145, 155, 170, 190, 195;
Same:	Iron: 130, 140, 150, 150.7, 160, 165.7, 175, 180.7, 185;
Steyr:	9100: 9105, 9115, 9125, 9145; CVT: 120, 130, 150, 170, 195, 6140, 6145, 6150, 6155, 6160, 6170, 6175, 6190, 6195;
Terrion:	ATM 4000: 4140, 4160, 4180;

Kompatybilny z

Nr Art. 00.400.52.3-A02 Standard 	Nr Art. 00.833.00.0-A02 Wkłady 	Nr Art. 00.833.01.0-A02 Wkłady 	Nr Art. 03.6330.44-A02 Wkłady 	Nr Art. 05.6330.16-A02 Wkłady
Nr Art. 05.6330.51-A02 Wkłady 	Nr Art. 05.6330.61-A02 Wkłady 	Nr Art. 05.6330.70-A02 Wkłady 	Nr Art. 07.6330.32-A02 Wkłady 	Nr Art. 07.6330.42-A02 Wkłady
Nr Art. 07.7330.04-A02 Wkłady 	Nr Art. 07.7330.05-A02 Wkłady 	Nr Art. 03.7330.60-A02 Płyty adaptacyjne z uchwytem 	Nr Art. 03.7330.65-A02 Płyty adaptacyjne z uchwytem 	Nr Art. 07.7330.52-A02 Płyty adaptacyjne z uchwytem

Kompatybilny z

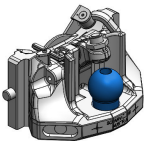
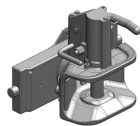
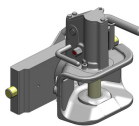
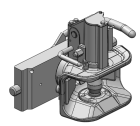
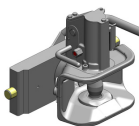
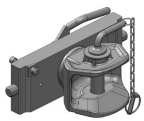
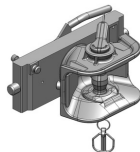
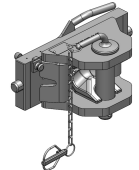
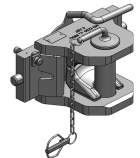
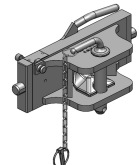
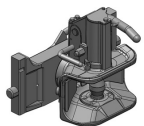
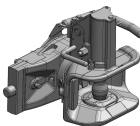
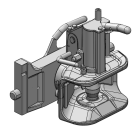
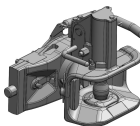
<p>Nr Art. 85.6330.70-A02 Lenkkugel K80® EAMS</p> 	<p>Nr Art. 03.3301.121-A02 Standard z płytą adaptacyjną</p> 	<p>Nr Art. 03.3301.221-A02 Standard z płytą adaptacyjną</p> 	<p>Nr Art. 03.3303.121-A02 Standard z płytą adaptacyjną</p> 	<p>Nr Art. 03.3303.221-A02 Standard z płytą adaptacyjną</p> 
<p>Nr Art. 03.3305.011-A02 Standard z płytą adaptacyjną</p> 	<p>Nr Art. 03.3305.06-A02 Standard z płytą adaptacyjną</p> 	<p>Nr Art. 03.3306.031-A02 Standard z płytą adaptacyjną</p> 	<p>Nr Art. 03.3307.031-A02 Standard z płytą adaptacyjną</p> 	<p>Nr Art. 03.3308.031-A02 Standard z płytą adaptacyjną</p> 
<p>Nr Art. 07.3303.121-A02 Standard z płytą adaptacyjną</p> 	<p>Nr Art. 07.3303.191-A02 Standard z płytą adaptacyjną</p> 	<p>Nr Art. 07.3303.221-A02 Standard z płytą adaptacyjną</p> 	<p>Nr Art. 07.3303.291-A02 Standard z płytą adaptacyjną</p> 	<p>Nr Art. 07.3301.50-A02 Zautomatyzowane</p> 